

Sterenn

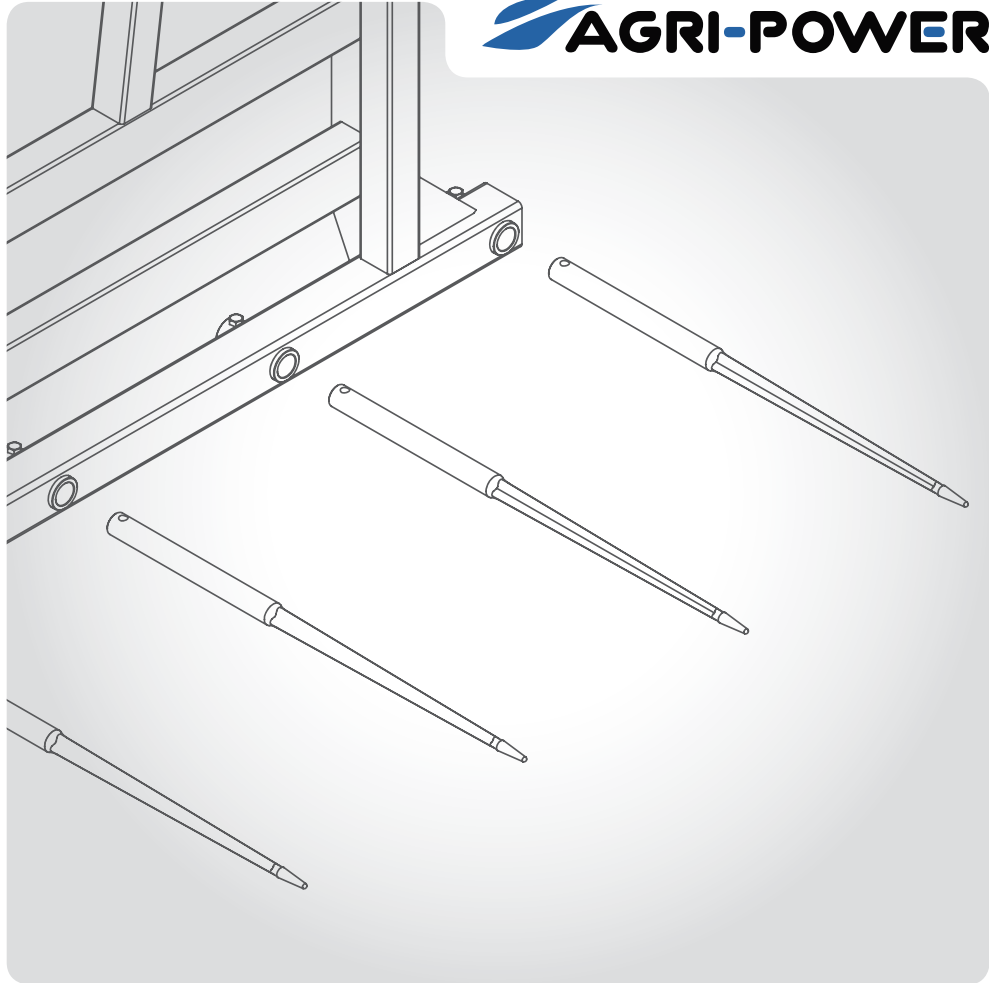

2015
2016

AGRI-POWER



PÚAS CARGA PACAS



PÚAS CARGA PACAS

 **AGRI-POWER**
Best value for money

Proceso de fabricación
exclusivo

Resistencia ante una carga de

900 kg

situada a 10 centímetros del
final de la púa



Púas roscadas  **p.4**

Púas pletinas roscadas  **p.4**

Púas con agujero  **p.6**

Púas curvas roscadas  **p.8**

Púas curvas con agujero  **p.8**

Púas tipo bayoneta roscadas  **p.9**

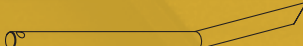

Púas plegadas con agujero  **p.9**

Casquillos para púas  **p.10**

Tuercas cónicas y arandelas cónicas para centrar **p.10**

Sterenn 

ZA de Beaucé – Route de Saint-Malo
35520 La Mézière - FRANCIA
Tel. 0033 2 99 13 05 97 – Fax 0033 2 99 13 05 19
www.groupe-sterenn.com

Ø 36 mm  Perfil 

Cono corto - Rosca M20x1,5 

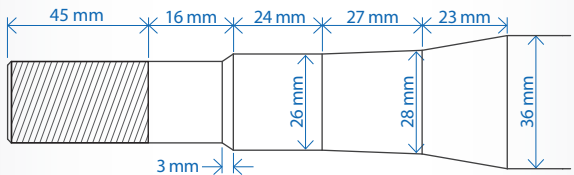

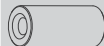
Longitud (mm)	Adaptable a	kg	Ref.	
650	Agram, Fauchoux	3	208732	215472



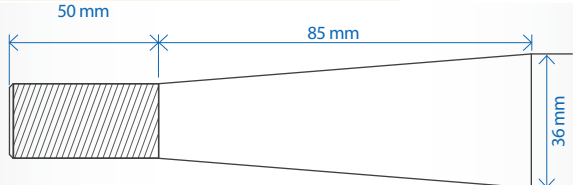

Ø 36 mm Perfil 

Cono largo - Rosca M20x1,5

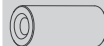

Longitud (mm)	Adaptable a	kg	Ref.	
680	Alo, KV, Stoll	3,4	208728	214571
800	Alo, Desvoys, Kongskilde, MF, KV, Stoll	3,9	215419	



Ø 36 mm  Perfil 

Cono corto - Rosca M22x1,5 

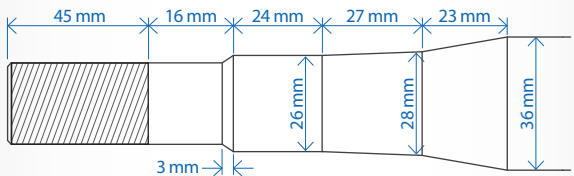

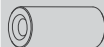

Longitud (mm)	Adaptable a	kg	Ref.	
800	Agram, Fauchoux, Magsi Tenias, El-Leon, BMH	3,5	215423	215472
1100	Agram, Fauchoux, Magsi Tenias, El-Leon, BMH	5,9	215425	
1300	Agram, Fauchoux, Magsi Tenias, El-Leon	7,4	208733	215469
1400	Agram, Fauchoux, Tenias, El-Leon	8,3	215428	

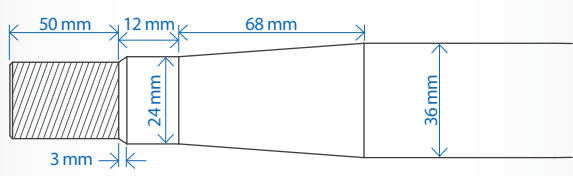

Ø 36 mm Perfil 

Cono largo - Rosca M20x1,5 



Longitud (mm)	Adaptable a	kg	Ref.	
1000	Universelle	5,1	217737	215470



LARGO ROSCA

Ø 36 mm Perfil 

Cono corto - Rosca M22x1,5 

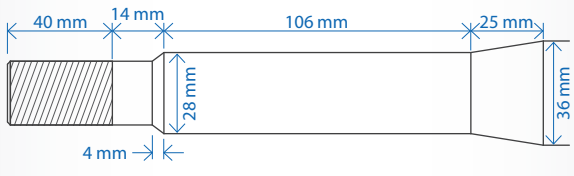



Longitud (mm)	Adaptable a	kg	Ref.	
850	Agram, Fauchoux	4	217735	-

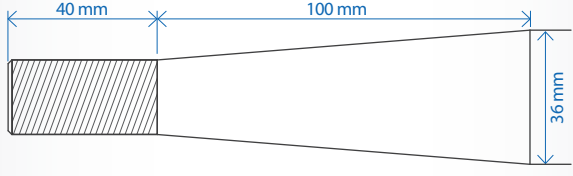

Ø 36 mm Perfil 

Cono largo - Rosca M20x1,5



Longitud (mm)	Adaptable a	kg	Ref.	
1100	Agram, Desvoys, Kongskilde, KV	5,1	208729	
1250	KV	7,4	208730	215470
1400	KV	8,6	208731	





Ø 36 mm

Perfil

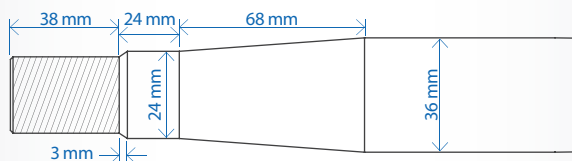

Cono largo - Rosca M22x1,5

AGRI-POWER

Longitud (mm)	Adaptable a	kg	Ref.	
680	Agram, Alo, Fauchoux, MF BMH, JD	2,8	215420	215471
800	Agram, Alo, Fauchoux, MF, Tanco, JD	3,5	215422	
900	JD	4,3	217736	
950	Universelle	4,7	406779	
1000	JD	5,1	217738	
1100	Desvoys, JD	5,9	215426	
1200	JD	6,7	217739	
1400	Desvoys, JD	8,3	215427	

Ø 45 mm

Perfil



Cono largo - Rosca M28x1,5

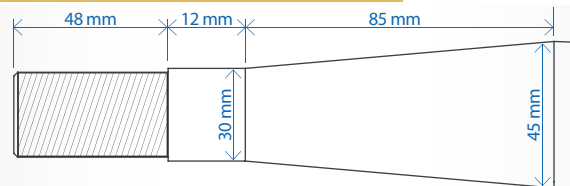

Longitud (mm)	Adaptable a	kg	Ref.	
810	Alo, KV, Quicke, MF	6	208737	209298
980	Alo, KV, Quicke, MF	8,3	208738	
1100	Alo, KV	9,85	208739	
1250	Alo, KV, Quicke, MF	11,63	208740	
1400	Universelle	13,65	208741	

Ø 50 mm

Perfil



Cono largo - Rosca M28x1,5

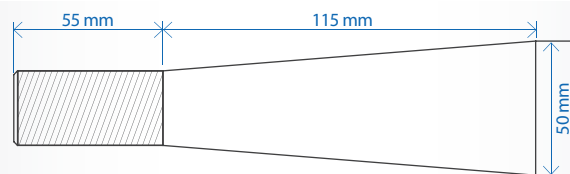

Longitud (mm)	Adaptable a	kg	Ref.	
880	Manitou	10,5	208743	209299
980	Manitou	11,63	208744	
1100	Manitou	13,48	208745	
1400	Manitou	18,30	208746	

Ø 36 mm



Púas pletinas

Perfil

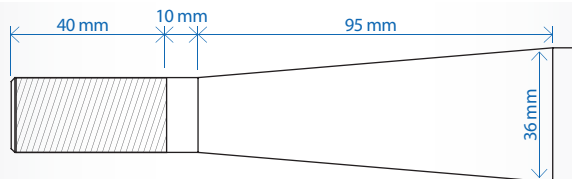

Cono largo - Rosca M20x1,5

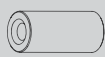

Longitud (mm)	Adaptable a	kg	Ref.		
1100	Desvoys, Kongskilde, KV, Stoll	4,9	215459	-	-
1250	Desvoys, Kongskilde, KV, Stoll, Quicke	5,27	215458		
1400	Desvoys, Kongskilde, KV, Quicke	8	215460		

Ø 42 mm

Perfil

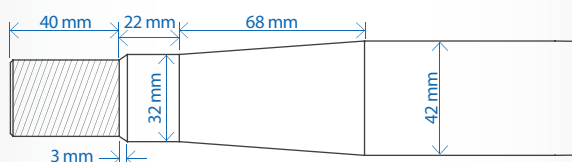

Cono largo - Rosca M28x1,5

AGRI-POWER

Longitud (mm)	Adaptable a	kg	Ref.	
810	Agram, Fauchoux, JD	4,85	215434	215465
900	Agram, Fauchoux, JD	5,85	215435	
1000	Agram, Fauchoux, JD	7	215436	
1100	Agram, Fauchoux, JD	8,1	215437	
1200	Agram, Fauchoux, JD	9,1	215438	
1400	Agram, Fauchoux, JD	11,5	215442	

Ø 50 mm

Perfil



Cono largo - Rosca M28x1,5

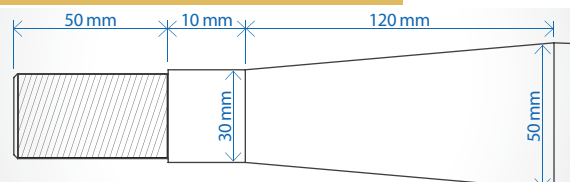



Longitud (mm)	Adaptable a	kg	Ref.	
810	KV	7,18	208747	209299
980	KV	10,27	208748	
1100	KV	11,90	208749	
1250	KV	14,20	208750	
1400	KV	16,70	208751	

Ø 28/22 mm Perfil 

Agujero : 6 mm

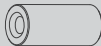

Longitud (mm)	Adaptable a	kg	Ref.	
740	Audureau	3,2	215445	-





Ø 35 mm Perfil 

Agujero : 11 mm

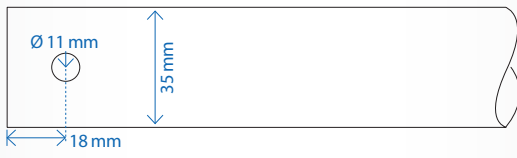
AGRI-POWER

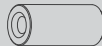



Longitud (mm)	Adaptable a	kg	Ref.	
760	Agram, Emily, Magsi	4,2	208723	217294





Ø 30/22 mm Perfil 

Agujero : 11 mm





Longitud (mm)	Adaptable a	kg	Ref.	
820	Samson	3	215451	205371



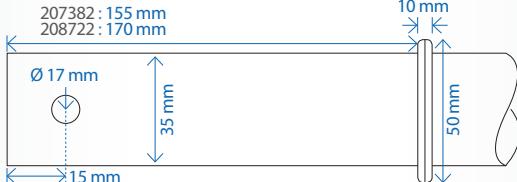

Ø 35 mm Perfil 

Agujero : 17 mm



Longitud (mm)	Adaptable a	kg	Ref.	
850	Agram, Alo	3,9	207382	-
850	Emily, Magsi	3,9	208722	-





Ø 30 mm Perfil 

Agujero : 11 mm

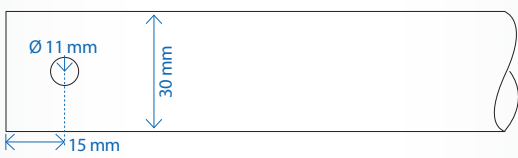
AGRI-POWER

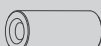

Longitud (mm)	Adaptable a	kg	Ref.	
760	Chilton, Magsi, MX	3,1	215449	217761





Ø 35 mm Perfil 

Agujero : 11 mm

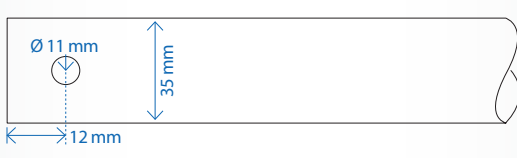
AGRI-POWER

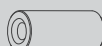

Longitud (mm)	Adaptable a	kg	Ref.	
850	Agram, Emily, Magsi	4,5	215483	217294
1150	Agram, Emily, Magsi	6,7	215484	-



Ø 35/25 mm Perfil 
 Agujero : 11 mm 

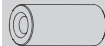

Longitud (mm)	Adaptable a		Ref.	
820	MX	3,9	215452	
860	Chilton, MX	4,15	215456	217477
1200	Chilton, MX	7,25	215430	



Ø 42 mm Perfil 
 Agujero : 12 mm 

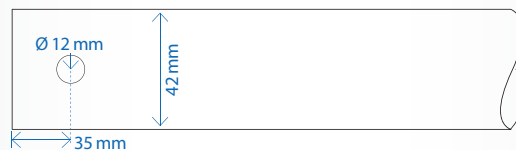

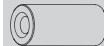
Longitud (mm)	Adaptable a		Ref.	
900	Universelle	6,5	215457	
1000	Universelle	7,5	209877	215467
1250	Universelle	9,65	215431	
1400	Universelle	11,5	215441	



Ø 36 mm Perfil 
 Agujero : 12 mm 

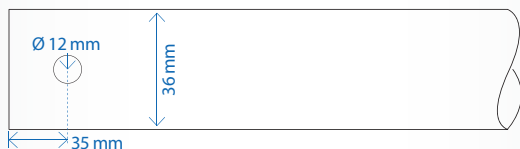

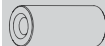

Longitud (mm)	Adaptable a		Ref.	
950	Universelle	4,7	205648	
1100	Universelle	6,1	215433	218698
1400	Universelle	8,3	215440	

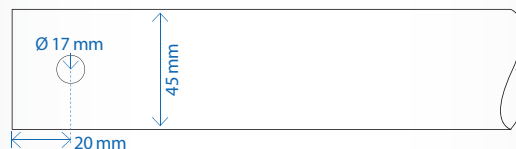

Ø 45 mm Perfil 
 Agujero : 17 mm 





Longitud (mm)	Adaptable a		Ref.	
995	Universelle	7,2	215453	
1055	Emily, Magsi	8,85	219865	215648
1200	Emily, Magsi	10,5	215454	
1400	Universelle	12	215455	

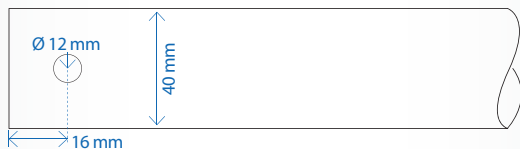

Ø 40 mm Perfil 
 Agujero : 12 mm 





Longitud (mm)	Adaptable a		Ref.	
1000	Universelle	7,1	208165	
1100	Universelle	8,1	207821	208003
1250	MX	9,65	207822	
1400	Universelle	11,5	207823	

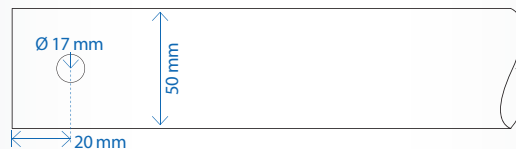

Ø 50 mm Perfil 
 Agujero : 17 mm 



Longitud (mm)	Adaptable a		Ref.	
1050	Agram, Emily, Magsi, BMH	9,6	208742	215466
1200	Agram, Emily, Magsi	12,25	215429	



PÚAS CURVAS ROSCADAS

Ø 36 mm

Perfil



Cono largo - Rosca M20x1,5

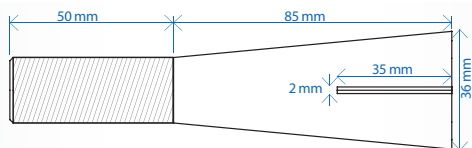

Longitud (mm)	Adaptable a	kg	Ref.	
600	KV, JD	2,70	208725	
680	KV, JD, Alo, MF	3,4	208726	208233
810	KV, JD	3,9	208727	



Ø 38 mm

Perfil



Cono largo - Rosca M22x1,5

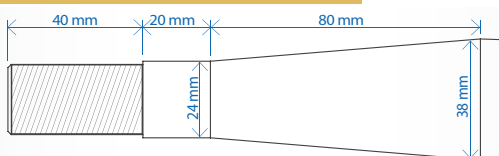

Longitud (mm)	Adaptable a	kg	Ref.	
660	Universelle	2,9	215421	
770	Universelle	3,05	215424	



Ø 42 mm

Perfil



Cono largo - Rosca M28x1,5

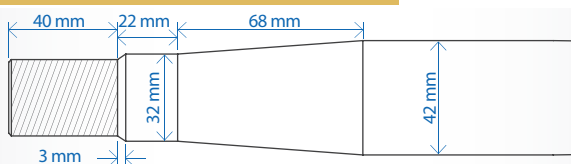

Longitud (mm)	Adaptable a	kg	Ref.	
750	Universelle	4,85	219855	215465



Ø 35 mm

Perfil



Agujero : 10 mm

AGRI-POWER

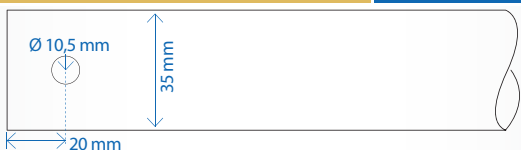

Longitud (mm)	Adaptable a	kg	Ref.	
640	Emily, JD, Magsi	3,8	208724	217294



PÚAS CURVAS CON AGUJERO

Ø 25 mm

Perfil



Agujero : 10 mm

AGRI-POWER

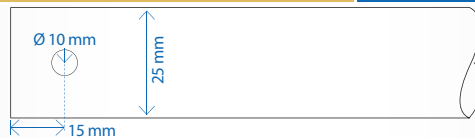

Longitud (mm)	Adaptable a	kg	Ref.	
420		1,40	208040	-
430	Lamy	1,46	209806	218094
480		1,70	407918	-
530	MX, Chilton, Magsi	1,9	217335	218094
550	MX	2,0	208122	-



Ø 35 mm

Perfil



Agujero : 11 mm

AGRI-POWER

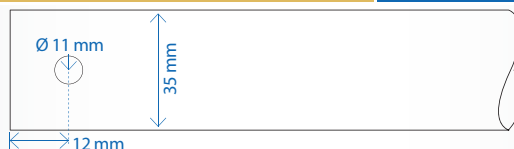

Longitud (mm)	Adaptable a	kg	Ref.	
665	Universelle	3,4	219423	217294



Ø 35 mm

Perfil



Agujero : 8 mm

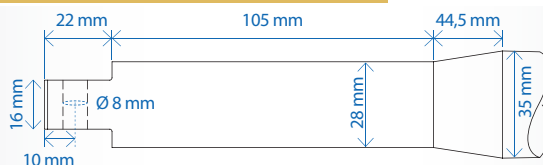

Longitud (mm)	Adaptable a	kg	Ref.	
680	Alo, Agram	2,6	208948	-



Ø 36/35/25 mm

Perfil



Agujero : 11 mm

AGRI-POWER

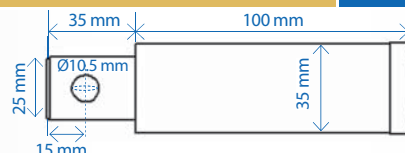

Longitud (mm)	Adaptable a	kg	Ref.	
530	Universelle	2,75	407915	407916



PÚAS TIPO BAYONETA ROSCADAS

Ø 35 mm

Perfil



Cono largo - Rosca M24x1,5

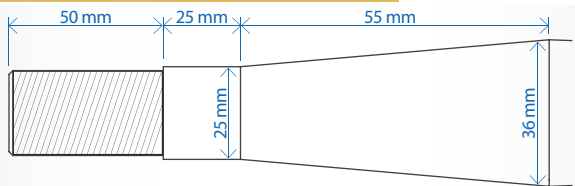

Longitud (mm)	Adaptable a	kg	Ref.	
---------------	-------------	----	------	--

820 KV 4 **208735**

910 KV 4,4 **208736**



Ø 36 mm

Perfil



Cono largo - Rosca M20x1,5

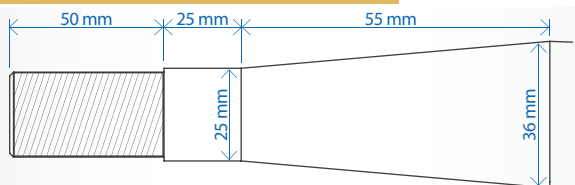

Longitud (mm)	Adaptable a	kg	Ref.	
---------------	-------------	----	------	--

820 KV 4 **208734** 208233



Ø 36 mm

Perfil



Cono largo - Rosca M22x1,5

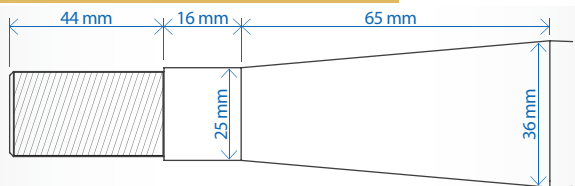

Longitud (mm)	Adaptable a	kg	Ref.	
---------------	-------------	----	------	--

810 Audureau, Kuhn, MC Hale 3,4 **215416**



Ø 36 mm

Perfil



Cono corto - Rosca M22x1,5

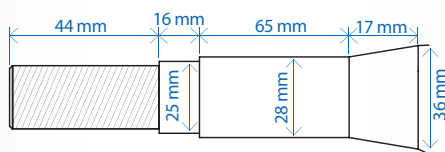

Longitud (mm)	Adaptable a	kg	Ref.	
---------------	-------------	----	------	--

880 Audureau, Kuhn 3,7 **215417**



PÚAS PLEGADAS CON AGUJERO

Ø 25 mm

Perfil



Agujero : 12,5 mm

AGRI-POWER

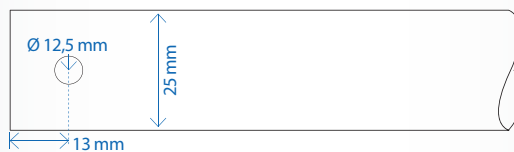

Longitud (mm)	Adaptable a	kg	Ref.	
---------------	-------------	----	------	--

520 Emily, JD, Magsi 1,83 **208719** 218094



Ø 25 mm

Perfil



Agujero : 12,5 mm

AGRI-POWER

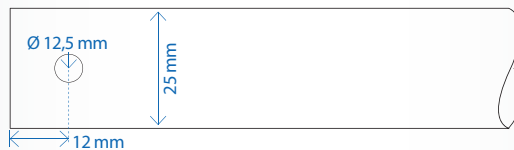

Longitud (mm)	Agujero	Adaptable a	kg	Ref.	
---------------	---------	-------------	----	------	--

548 Horizontal Chilton, MX 2 **215446**

548 Vertical Chilton, MX 2 **215447** 218094



Ø 28 mm

Perfil



Agujero : 12,5 mm

AGRI-POWER

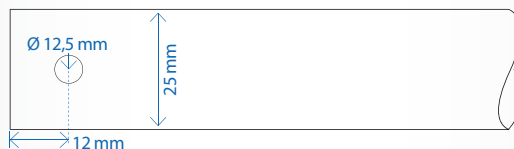

Longitud (mm)	Agujero	Adaptable a	kg	Ref.	
---------------	---------	-------------	----	------	--

420 Vertical Chilton, MX 2,56 **208720**

550 Horizontal Chilton, MX 2,56 **208721**



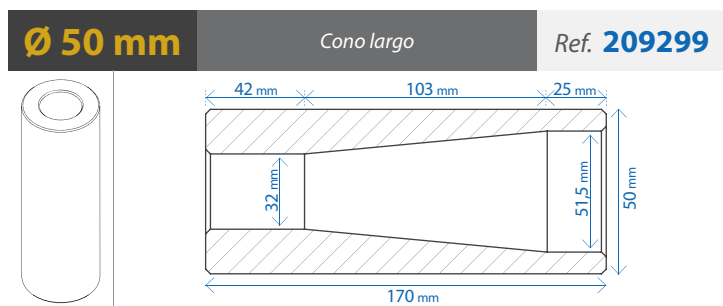
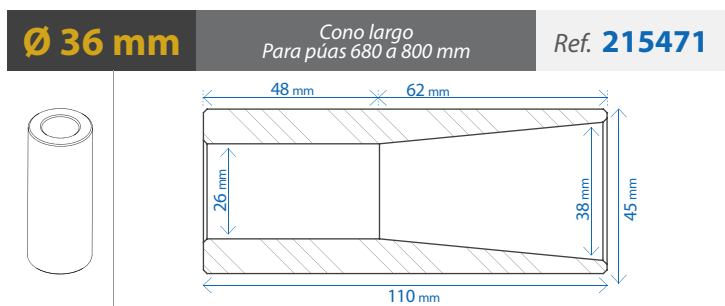
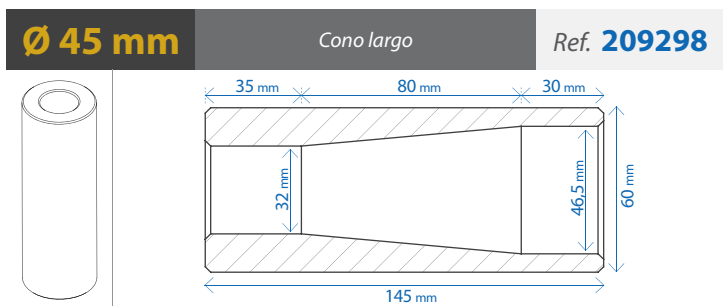
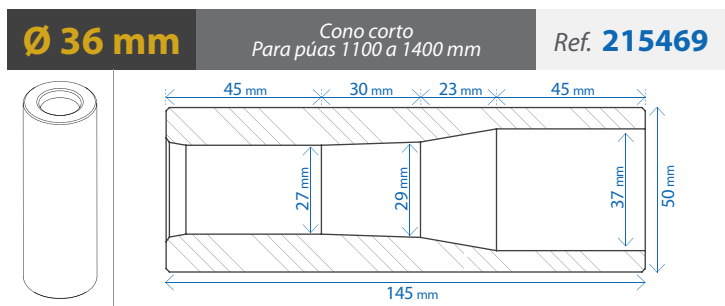
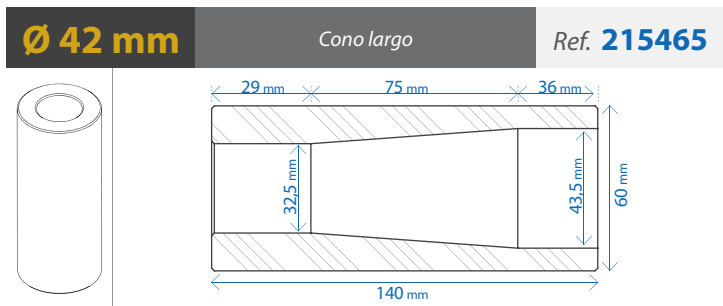
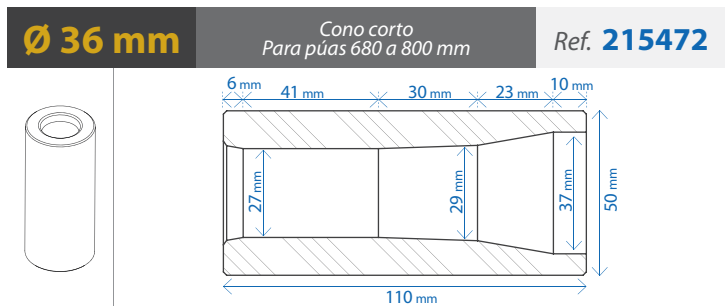
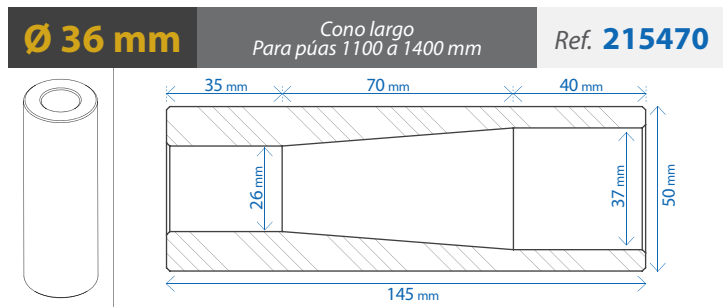
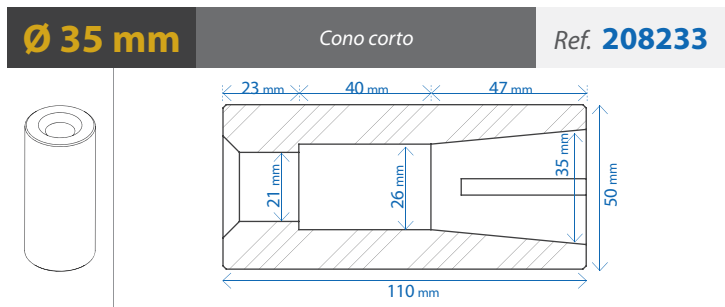

ARANDELAS CÓNICAS PARA CENTRAR & TUERCAS CÓNICAS

Arandelas cónicas para centrar

Ø	Ref.
36 mm	215462
42 mm	205055

Tuercas cónicas para centrar

Ø	Ref.
M 20 x 1,5	215463
M 22 x 1,5	215461
M 27 x 1,5	205401
M 28 x 1,5	215464

Ø 25 mm

Ref. 218094

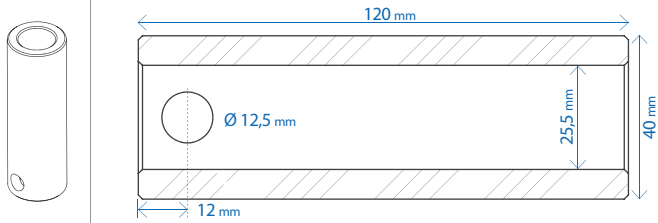

Ø 30 mm

Ref. 217761

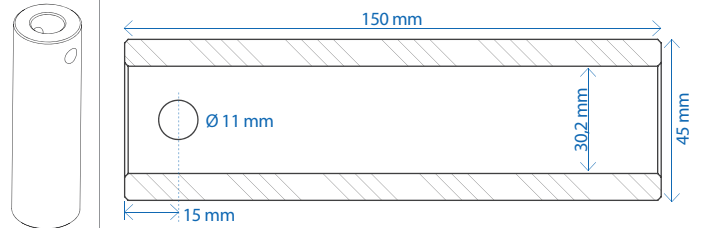

Ø 30/22 mm

Ref. 205371

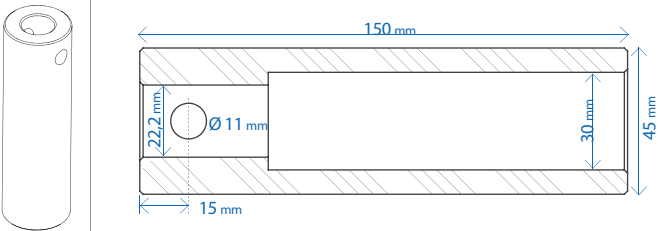

Ø 35 mm

Ref. 217294

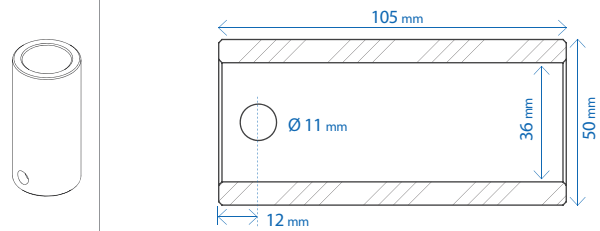

Ø 35 mm

Ref. 219426

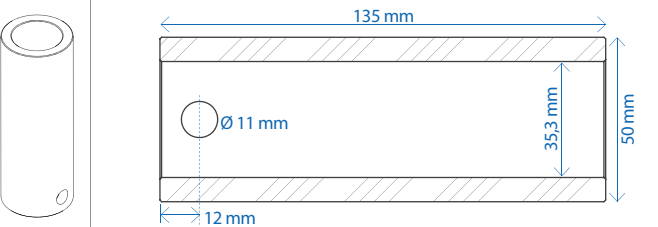

Ø 35 mm

Ref. 219427

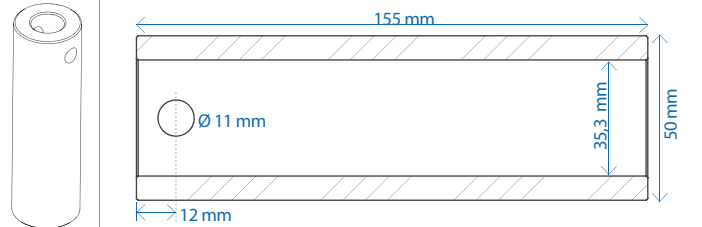

Ø 35/25 mm

Ref. 215477

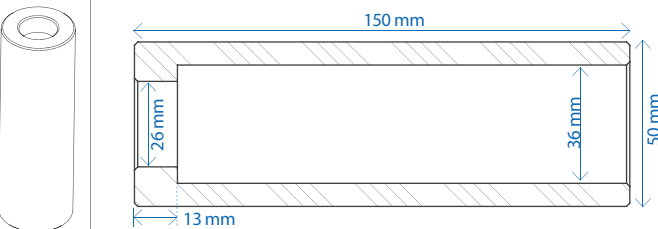

Ø 36 mm

Ref. 218698

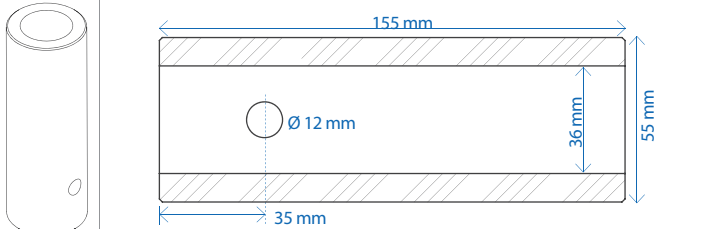

Ø 40 mm

Ref. 208003

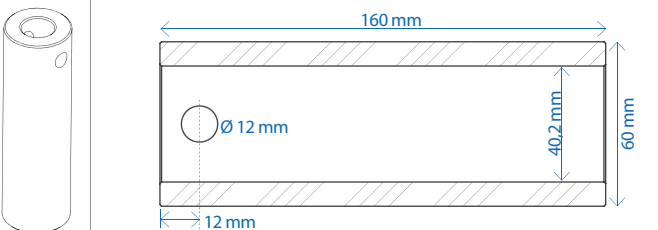

Ø 42 mm

Ref. 215467

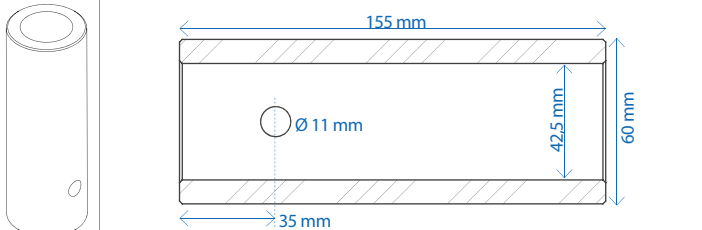

Ø 45 mm

Ref. 215468

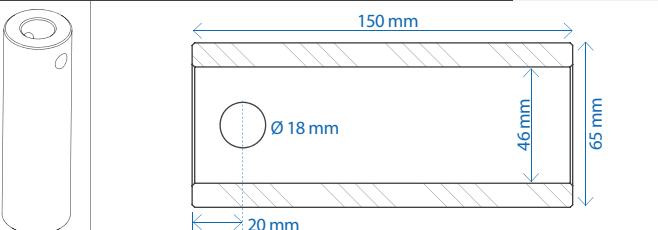

Ø 50 mm

Ref. 215466

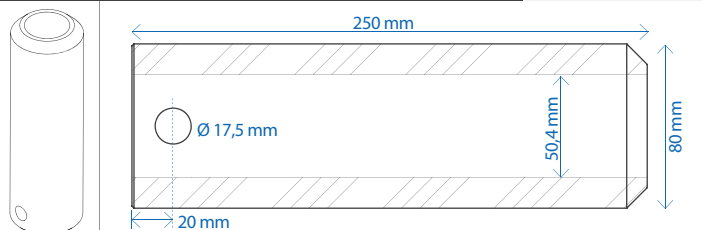

Localización



<https://maps.google.fr> --> Groupe Sterenn, Beauce, La Mézière



Avec Ecofolio
tous les papiers
se recyclent.